

Modelling of Plain Cement Concrete Pavement Patch Using ANSYS Workbench

Shrikant Madhav Harle¹, Prakash Pajgade²

¹Department of Civil Engineering, Professor Ram Meghe College of Engineering and Management, Badnera, India

²Department of Civil Engineering, Professor Ram Meghe Institute of Technology and Research, Badnera, India

Email address:

shrikantharle@gmail.com (S. M. Harle), ppajgade@gmail.com (P. Pajgade)

To cite this article:

Shrikant Madhav Harle, Prakash Pajgade. Modelling of Plain Cement Concrete Pavement Patch Using ANSYS Workbench. *American Journal of Civil Engineering*. Special Issue: Research and Development in Concrete Pavement. Vol. 6, No. 3-1, 2018, pp. 1-8.

doi: 10.11648/j.ajce.s.2018060301.11

Received: March 31, 2017; **Accepted:** April 5, 2017; **Published:** April 11, 2017

Abstract: The concrete roads have many advantages as compared to the flexible pavement. The durability, Strength and life are the main characteristics of good road. In the developing countries like India, the flexible roads are deteriorated very easily due to heavy loads of the vehicles. It is important to construct the durable roads and there should not be necessity of maintenance after short span. Therefore it is also important to know the stresses and strains coming out on the concrete pavement due to different loads of vehicles. The present paper has consider these aspects using analysis in finite element software i.e. ANSYS workbench. The present paper has describes the deformation, maximum stress and maximum strain. From the results it has been shown that the maximum stress has occurred at the top surface of the model.

Keywords: Concrete Pavement, ANSYS, Stress, Strain and Deformation

1. Introduction

Now days the cement concrete pavement is becoming popular as it has many advantages as compared to bituminous or asphalt pavement. The study of the concrete pavement to minimize the stresses and cracks occurred due to moving or dynamic loads are the main issue of this research work.

Almost all rigid pavements are made up of Portland Cement Concrete (PCC), typically consisting of PCC surface course constructed over either the subgrade or base course over subgrade. The PCC course is the stiffest and provides majority of strength to the pavement. The base course and the subgrade provide drainage and frost protection to the pavement and also contribute to the strength. Rigid pavements can be classified into three major categories:

a) Jointed plain concrete pavement (JPCP): In JPCP, the pavement is divided into individual slabs separated by contraction joints using dowels (for load transfer) and tie bars

to connect adjacent slabs. This is the most common type of rigid pavement.

b) Jointed reinforced concrete pavement (JRCP): This type of pavement is similar to JPCP except that these slabs are much longer and are reinforced to withstand expansion and contraction due to temperature and moisture. The JRCP type is associated with long term performance problems and is not commonly used in the US.

c) Continuously reinforced concrete pavement (CRCP): In this type of rigid pavement the slabs are reinforced and continuous without any joints except construction joints.

2. Methodology

The finite element software i.e. ANSYS is the software in which analysis of concrete pavement is carried out. The following table shows the required data to be considered for the analysis.

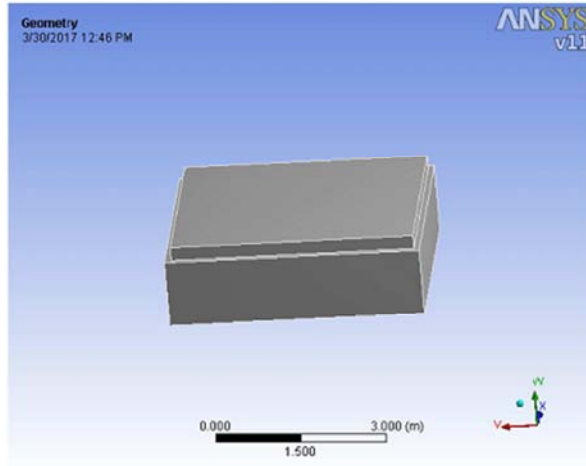

Figure 1. Geometry of the model.

Table 1. Units.

Unit System	Metric (m, kg, N, °C, s, V, A)
Angle	Degrees
Rotational Velocity	rad/s

Table 2. Geometry of the Model.

Object Name	Geometry
State	Fully Defined
Definition	
Source	Unnamed.agdb
Type	DesignModeler
Length Unit	Millimeters
Element Control	Program Controlled
Display Style	Part Color
Bounding Box	
Length X	4.5 m
Length Y	1.4436 m
Length Z	4. m
Properties	
Volume	25.566 m ³
Mass	58803 kg
Statistics	
Bodies	37
Active Bodies	1
Nodes	14011
Elements	8142
Preferences	
Import Solid Bodies	Yes
Import Surface Bodies	Yes
Import Line Bodies	Yes
Parameter Processing	Yes
Personal Parameter Key	DS
CAD Attribute Transfer	No
Named Selection Processing	No
Material Properties Transfer	No
CAD Associativity	Yes
Import Coordinate Systems	No
Reader Save Part File	No
Import Using Instances	Yes
Do Smart Update	No
Attach File Via Temp File	No
Analysis Type	3-D
Mixed Import Resolution	None
Enclosure and Symmetry Processing	Yes

Table 3. Model Geometry parts.

Object Name	<i>Solid</i>
State	Meshed
Graphics Properties	
Visible	Yes
Transparency	1
Definition	
Suppressed	No
Material	Concrete
Stiffness Behavior	Flexible
Nonlinear Material Effects	Yes
Bounding Box	
Length X	4.5 m
Length Y	1.4436 m
Length Z	4. m
Properties	
Volume	25.566 m ³
Mass	58803 kg
Centroid X	2.2488 m
Centroid Y	0.71199 m
Centroid Z	2. m
Moment of Inertia Ip1	87240 kg·m ²
Moment of Inertia Ip2	1.7501e+005 kg·m ²
Moment of Inertia Ip3	1.0781e+005 kg·m ²
Statistics	
Nodes	14011
Elements	8142

Table 4. Model Geometry Body parts.

Object Name	<i>Rebar</i>
State	Suppressed
Graphics Properties	
Visible	No
Definition	
Suppressed	Yes
Material	Structural Steel
Bounding Box	
Length X	4.1629 m
Length Y	0. m
Length Z	3.5 m
Properties	
Volume	0. m ³
Mass	0. kg
Statistics	
Nodes	0
Elements	0

Table 5. Model Geometry Rebar Parts.

Object Name	<i>Line Body</i>	<i>Line Body</i>	<i>Line Body</i>	<i>Line Body</i>	<i>Line Body</i>
State	Suppressed				
Graphics Properties					
Visible	No				
Definition					
Suppressed	Yes				
Material	Structural Steel				
Nonlinear Material Effects	Yes				
Beam Section					
Bounding Box					
Length X	4.1629 m				
Length Y	0. m				
Length Z	0. m				
Properties					
Volume	0. m ³				

Object Name	<i>Line Body</i>	<i>Line Body</i>	<i>Line Body</i>	<i>Line Body</i>	<i>Line Body</i>
Mass	0. kg				
Length	4.1629 m				
Cross Section Area					
Cross Section IYY					
Cross Section IZZ					
Statistics					
Nodes	0				
Elements	0				

Table 6. Model Connections.

Object Name	<i>Connections</i>
State	Fully Defined
Auto Detection	
Generate Contact On Update	Yes
Tolerance Type	Slider
Tolerance Slider	0
Tolerance Value	1.5479e-002 m
Same Body Grouping	Yes
Transparency	
Enabled	Yes

Table 7. Model Connections – Contact Regions.

Object Name	<i>Bonded - Solid To Solid</i>
State	Fully Defined
Scope	
Scoping Method	Geometry Selection
Contact	1 Face
Target	4 Faces
Contact Bodies	Solid
Target Bodies	Solid
Definition	
Type	Bonded
Scope Mode	Manual
Suppressed	No
Advanced	
Formulation	Pure Penalty
Update Stiffness	Never

Table 8. Model Mesh.

Object Name	<i>Mesh</i>
State	Solved
Defaults	
Physics Preference	Mechanical
Relevance	0
Advanced	
Relevance Center	Coarse
Element Size	0.15 m
Shape Checking	Standard Mechanical
Solid Element Midside Nodes	Program Controlled
Straight Sided Elements	No
Initial Size Seed	Active Assembly
Smoothing	Low
Transition	Fast
Statistics	
Nodes	14011
Elements	8142

Table 9. Model Static structural Solution 1.

Object Name	Maximum Principal Elastic Strain	Maximum Principal Stress	Total Deformation	Stress Intensity	Equivalent Elastic Strain
State	Solved				
Scope					
Geometry	All Bodies				
Definition					
Type	Maximum Principal Elastic Strain	Maximum Principal Stress	Total Deformation	Stress Intensity	Equivalent (von-Mises) Elastic Strain
Display Time	End Time				
Results					
Minimum	3.9215e-013 m/m	-0.58441 Pa	0. m	5.5686e-002 Pa	1.8409e-012 m/m
Maximum	1.1927e-010 m/m	3.8242 Pa	1.1823e-010 m	3.2489 Pa	1.0487e-010 m/m
Information					
Time	1. s				
Load Step	1				
Substep	1				
Iteration Number	1				

Table 10. Model Static structural Solution 2.

Object Name	Directional Deformation	Normal Stress	Maximum Shear Stress	Middle Principal Stress
State	Solved			
Scope				
Geometry	All Bodies			
Definition				
Type	Directional Deformation	Normal Stress	Maximum Shear Stress	Middle Principal Stress
Orientation	X Axis			
Display Time	End Time			
Results				
Minimum	-1.0705e-010 m	-0.94427 Pa	2.7843e-002 Pa	-0.79451 Pa
Maximum	0. m	0.9432 Pa	1.6245 Pa	0.79191 Pa
Information				
Time	1. s			
Load Step	1			
Substep	1			
Iteration Number	1			

Table 11. Material Data for Concrete.

Structural	
Young's Modulus	3.e+010 Pa
Poisson's Ratio	0.18
Density	2300. kg/m ³
Thermal Expansion	1.4e-005 1/°C
Tensile Yield Strength	0. Pa
Compressive Yield Strength	0. Pa
Tensile Ultimate Strength	5.e+006 Pa
Compressive Ultimate Strength	4.1e+007 Pa
Thermal	
Thermal Conductivity	0.72 W/m·°C
Specific Heat	780. J/kg·°C

Table 12. Material Data for Structural Steel.

Structural	
Young's Modulus	2.e+011 Pa
Poisson's Ratio	0.3
Density	7850. kg/m ³
Thermal Expansion	1.2e-005 1/°C
Tensile Yield Strength	2.5e+008 Pa
Compressive Yield Strength	2.5e+008 Pa
Tensile Ultimate Strength	4.6e+008 Pa
Compressive Ultimate Strength	0. Pa
Thermal	
Thermal Conductivity	60.5 W/m·°C
Specific Heat	434. J/kg·°C
Electromagnetics	
Relative Permeability	10000
Resistivity	1.7e-007 Ohm·m

Table 13. Structural Steel – Strain life parameters.

Strength Coefficient Pa	9.20E+08
Strength Exponent	-0.106
Ductility Coefficient	0.213
Ductility Exponent	-0.47
Cyclic Strength Coefficient Pa	1.00E+09
Cyclic Strain Hardening Exponent	0.2

3. Results

The following figure shows the behavior of concrete pavement under different loading pattern as described above. The stress, strain and deformation is displayed with the help of figures and tables.

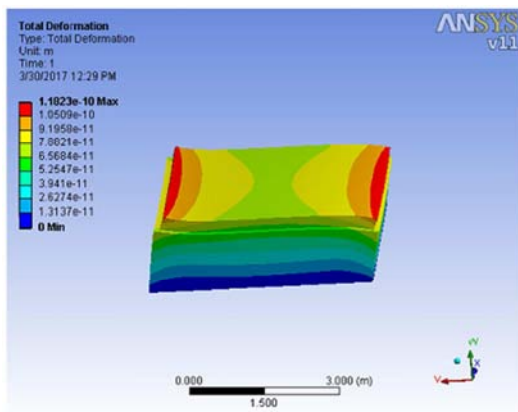

Figure 2. Total Deformation of model.

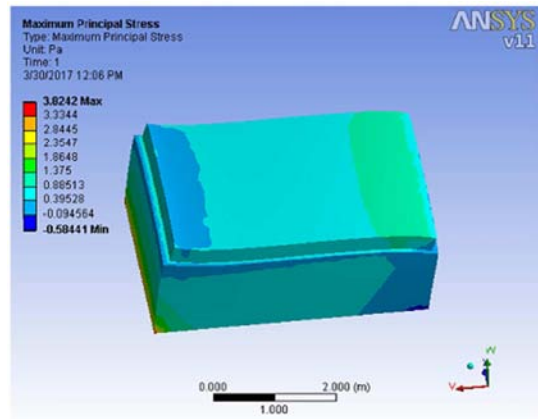

Figure 4. Maximum Principal Stress.

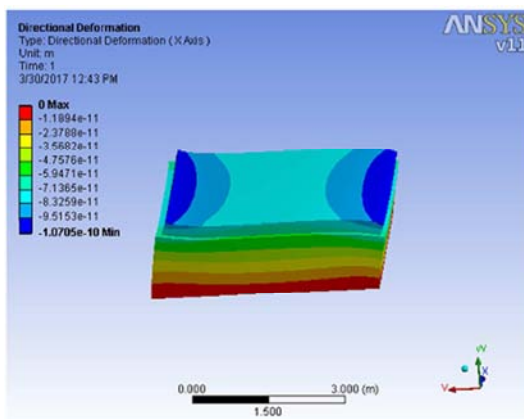

Figure 3. Directional Deformation of model.

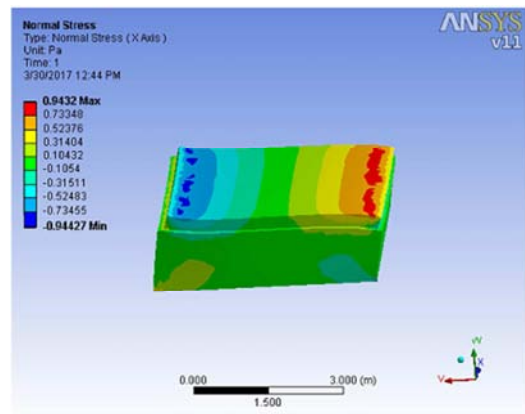

Figure 5. Normal Stress of model.

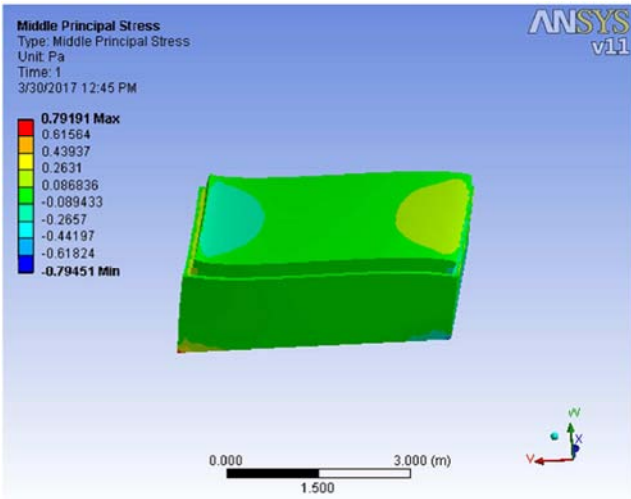

Figure 6. Middle Principal Stress of model.

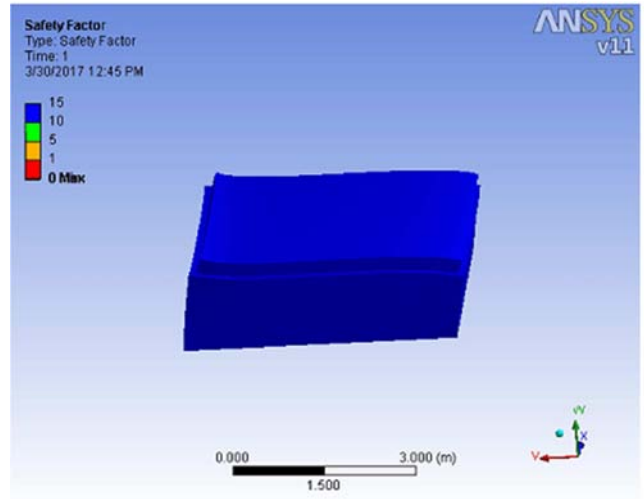

Figure 9. Safety Factor of model.

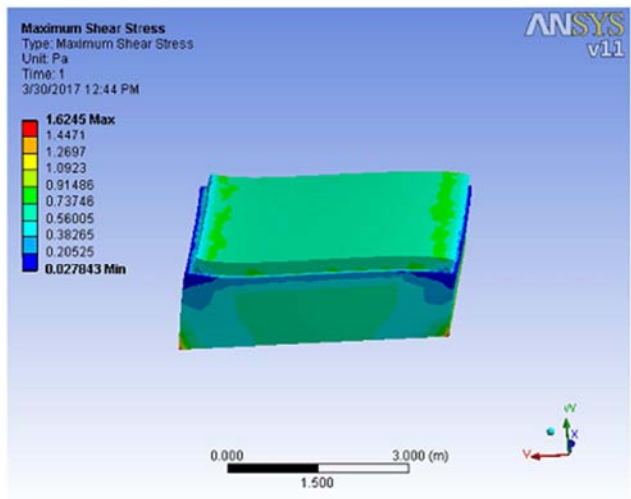

Figure 7. Maximum Shear stress of model.

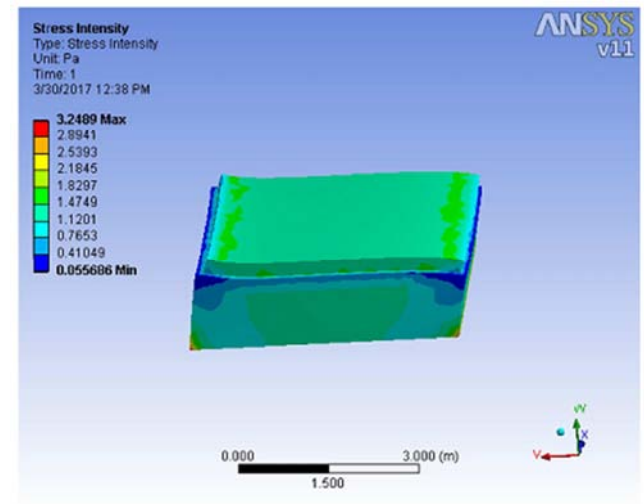

Figure 10. Stress Intensity of model.

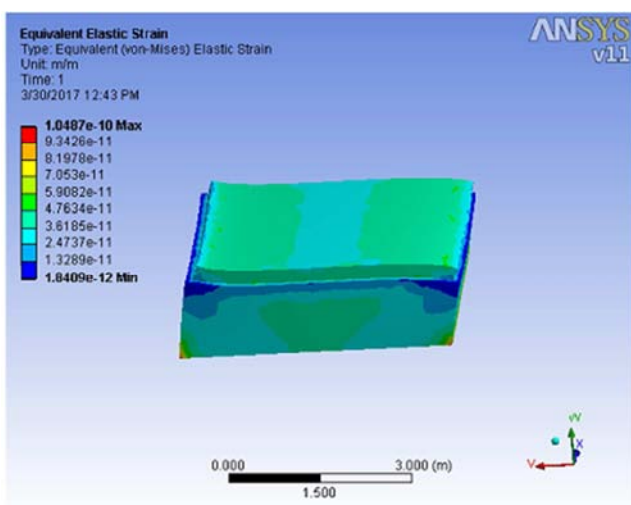

Figure 8. Equivalent Elastic Strain.

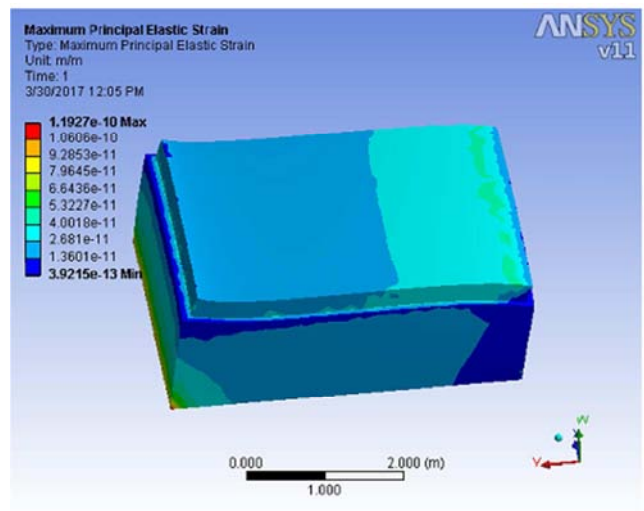

Figure 11. Maximum Principal Elastic Strain of Model.

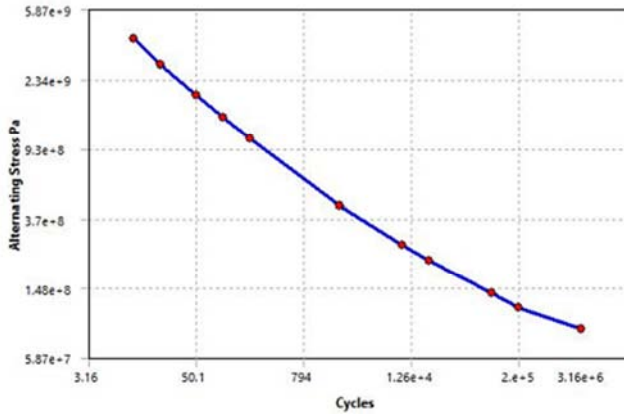

Figure 12. Alternating Stress.

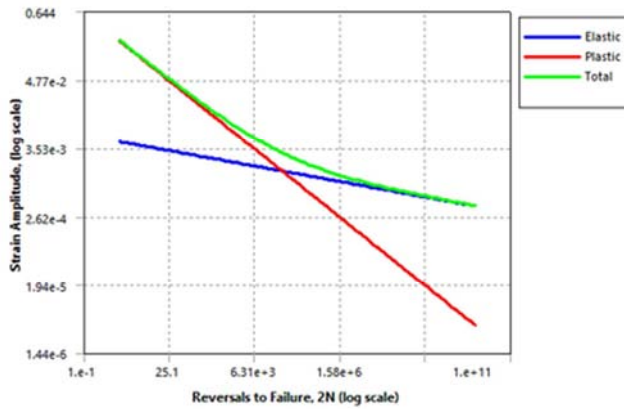

Figure 13. Structural Steel – strain life parameters.

4. Conclusion

- 1) From the above figures, it is clear that the maximum total deformation is at the top surface while maximum directional deformation is at the bottom surface.
- 2) Maximum principal stress and maximum normal stress is at the right corner of concrete pavement patch
- 3) Middle principal stress of the model is distributed almost equally all over the surface (top and bottom).
- 4) Maximum shear stress is at the top layer of the model
- 5) Equivalent elastic strain is observed to be at the corners of the concrete patch
- 6) Stress intensity is observed as maximum at the corners of the concrete pavement patch.
- 7) Maximum principal elastic strain is observed to be at right corner of the model.

- 8) The alternating stress is decreases as the number of cycle increases.
- 9) Plastic strain amplitude drastically decreases as compared to the elastic strain amplitude.
- 10) Total strain amplitude observed to be curved path.

References

- [1] Y. Chen, H. Zhang, X. Q. Zhu and D. W. Liu, “The Response of Pavement to the Multi-Axle Vehicle Dynamic Load”, International Conference of Electrical, Automation and Mechanical Engineering (EAME 2015).
- [2] Shwetha and Siddesha H, “Vibration Response of Deck Slab”, Proceedings of Twelveth IRF International Conference, 31st August 2014, Chennai, India.
- [3] Audrius Vaitkus, Judita Gražulyt and Rita Kleizien, “Influence of Static and Impact Load on Pavement Performance”, the 9th International Conference “Environmental Engineering” 22–23 May 2014, Vilnius, Lithuania.
- [4] Yu Liu, Zhanping You and Hui Yao, “An Idealized Discrete Element Model for Pavement-Wheel Interaction”, Journal of Marine Science and Technology, Vol. 23, No. 3, pp. 339-343 (2015).
- [5] Mostafa Yousefi Darestani, David P. Thambiratnam, Daksh Baweja and Andreas Nataatmadja, “Dynamic Response of Concrete Pavements under Vehicular Loads”, Proceedings IABSE Symposium - "Response to Tomorrow's Challenges in Structural Engineering" 92, pages pp. 104-105, Budapest, Hungary, 2006.
- [6] Mohammed Maaz Salman and Prof. Amaresh S Patil, “Analytical Study of Steel Fibre Reinforced Rigid Pavements Under Moving Load”, International Journal for Scientific Research & Development, Vol. 2, Issue 07, 2014.
- [7] Prof. Shrikant Harle and Prof. Prakash S. Pajgade, “Analysis of plain Concrete pavement in ANSYS”, Journal of Construction & Building Materials Engineering, Volume 3, Issue 1, pages 1-10, March 2017.
- [8] Prof. Shrikant Harle and Prof. Prakash S. Pajgade, "Cement Grouted Macadam: A Review", Journal of Ceramics and Concrete Sciences, Volume 2, Issue 1, page 1-8, Jan 2017.
- [9] Mr. Piyush Madke, Prof. Shrikant Harle, ‘Plastic Cell Filled Concrete Road: A Review’, Journal of Structural and Transportation Studies, Volume 1 Issue 3, pp 1-15, 2016.
- [10] Prof. Shrikant Harle and Prof. Prakash S. Pajgade, “White Topping In Roads: Review”, Journal of Structural and Transportation Studies, Volume 1, Issue 3, 2016.